



Voorgevel

Linker zijgevel

Rechter zijgevel

Achtergevel

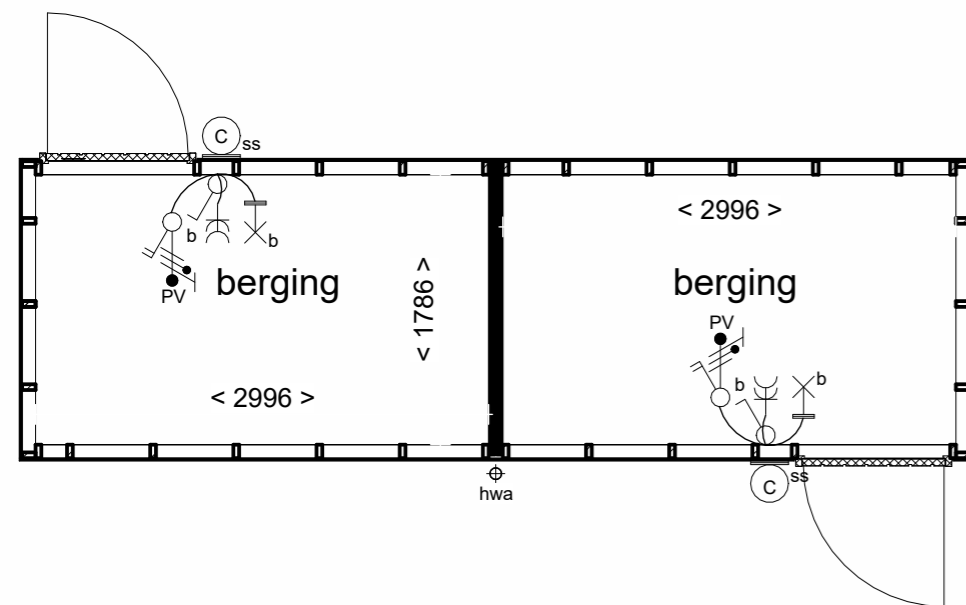

Begane grond

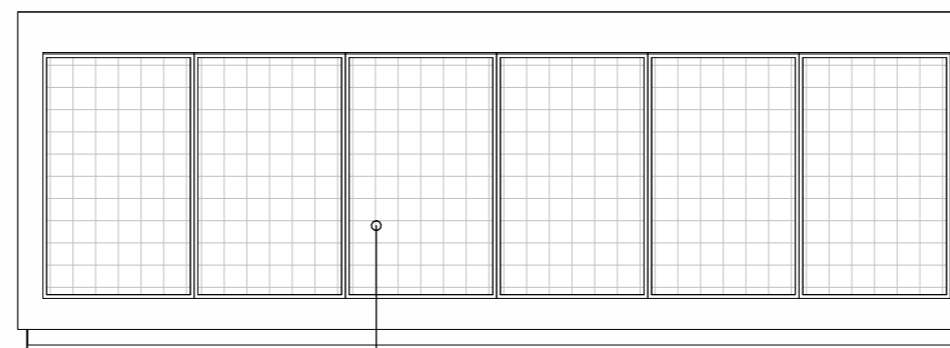

Dakaanzicht

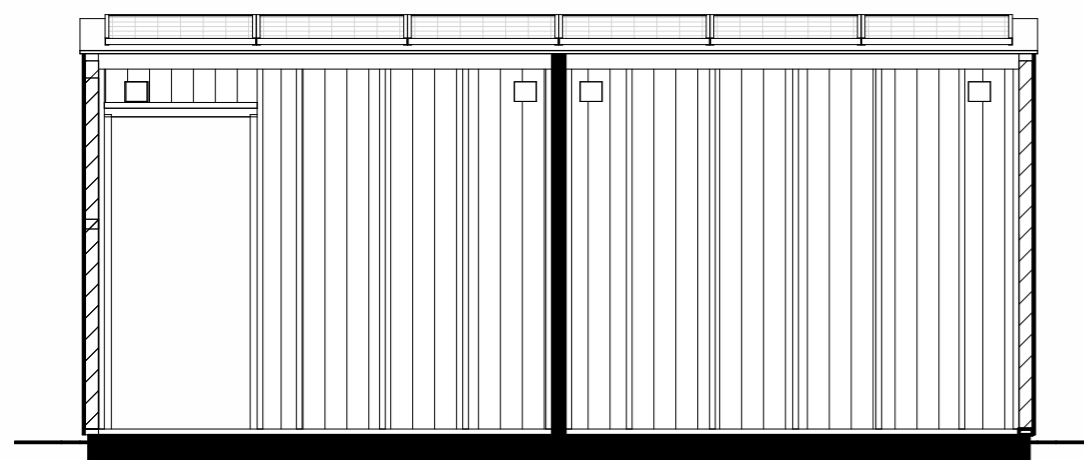

Doorsnede A-A

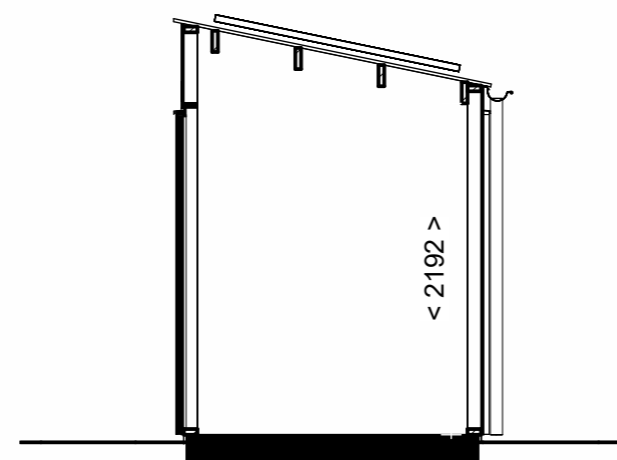

Doorsnede B-B

Als getekend:

bnr. 389 - 390
 bnr. 391 - 392
 bnr. 393 - 394
 bnr. 428 - 429
 bnr. 430 - 431
 bnr. 432 - 433
 bnr. 434 - 435

Gespiegeld:

bnr. 343 - 344
 bnr. 345 - 346
 bnr. 347 - 348
 bnr. 451 - 452
 bnr. 453 - 454
 bnr. 455 - 456
 bnr. 457 - 458
 bnr. 459 - 460



Tekening: **Berging A**

Woningtype: -

Bouwnummer:

Bladnummer: **VT-BE06**

Schaal: **1:50**

Datum: **02-12-2024**



Voorgevel



Linker zijgevel

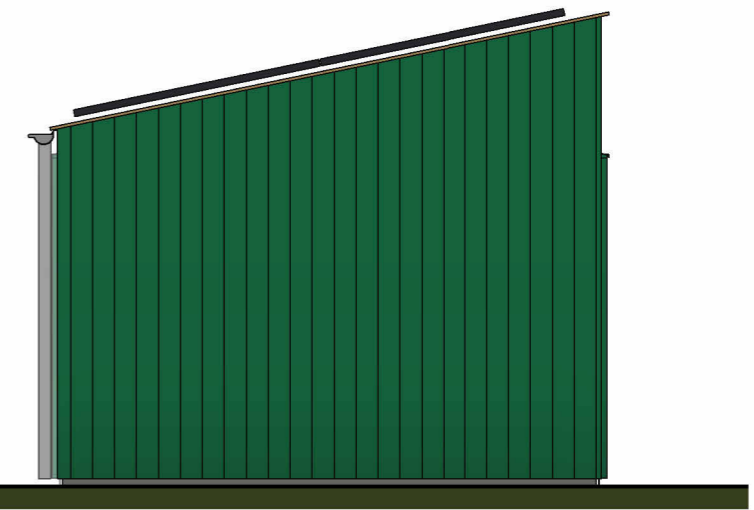

Rechter zijgevel

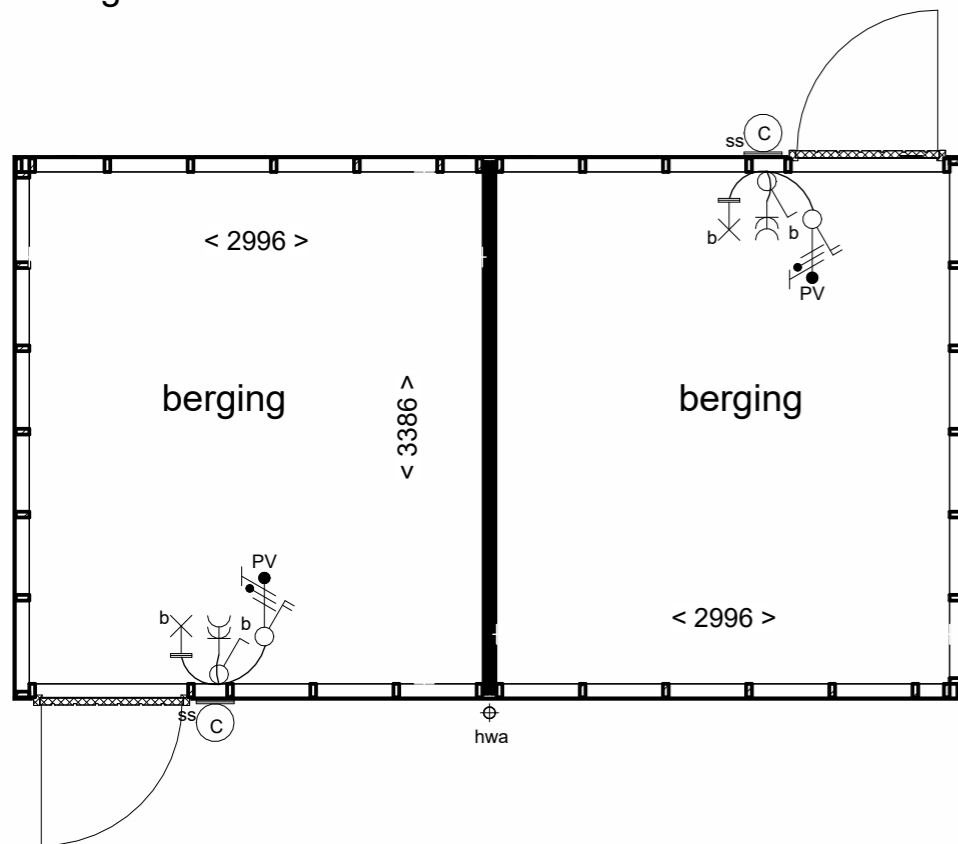

Begane grond

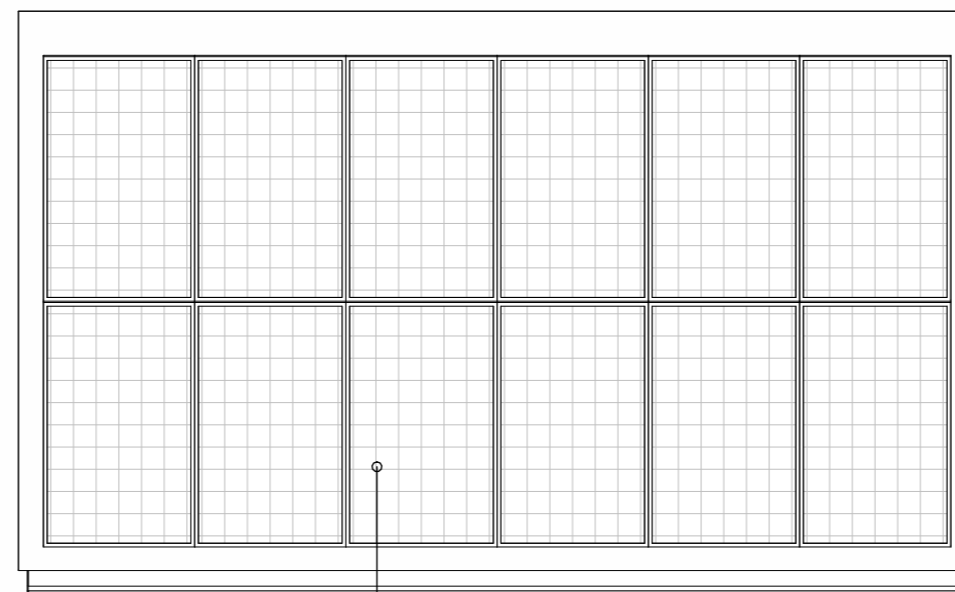

Dakaanzicht

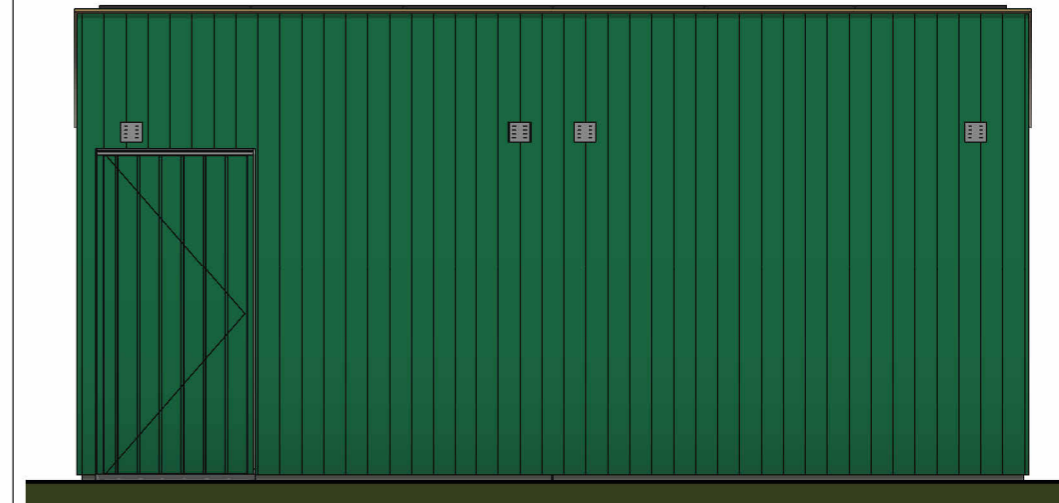

Achtergevel

Als getekend:	Gespiegeld:
bnr. 443 - 444	bnr. 396 - 397
bnr. 445 - 446	bnr. 398 - 399
bnr. 447 - 448	bnr. 400 - 401
bnr. 449 - 450	bnr. 423 - 424
bnr. 461 - 462	bnr. 425 - 426
bnr. 463 - 464	bnr. 437 - 438
	bnr. 439 - 440
	bnr. 441 - 442

**ALLEMAAL
YIELEYAAL**

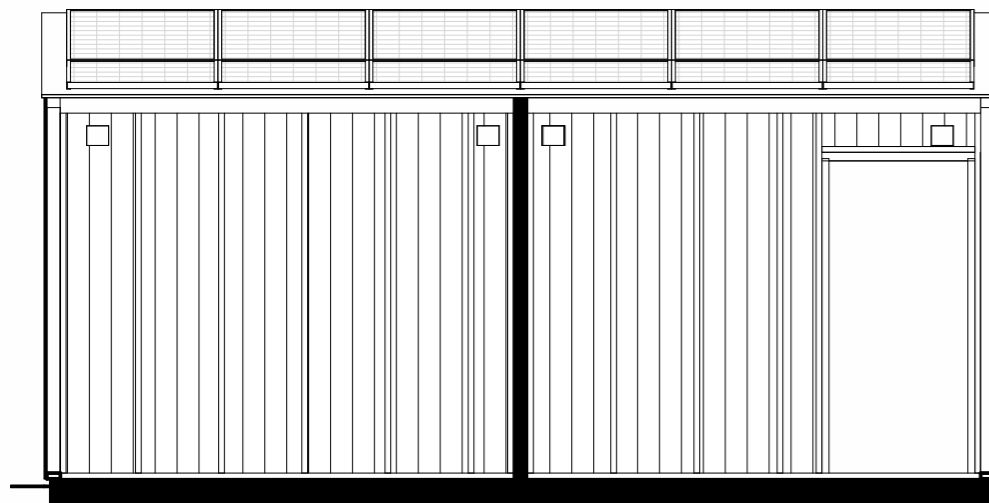

Doorsnede A-A

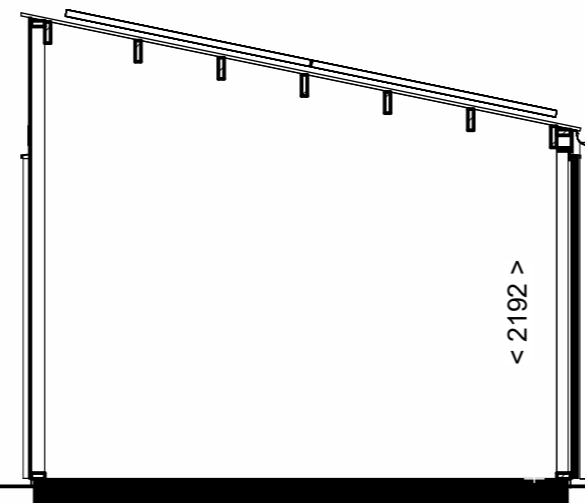

Doorsnede B-B



3D aanzicht

Tekening: **Berging B**

Woningtype: -

Bouwnummer:

Bladnummer: **VT-BE07**

Schaal: **1:50**

Datum: **02-12-2024**



Voorgevel



Linker zijgevel

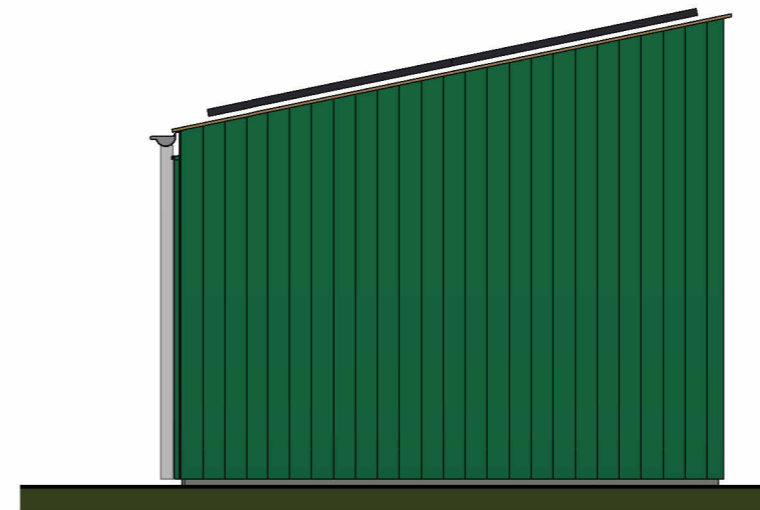

Rechter zijgevel

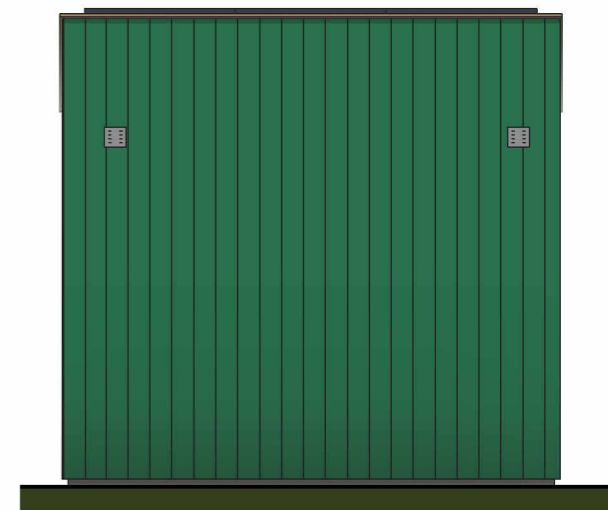

Achtergevel

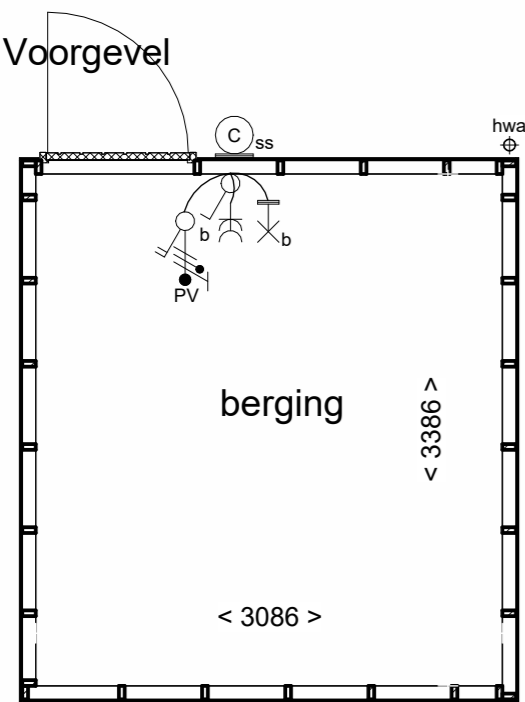

Begane grond

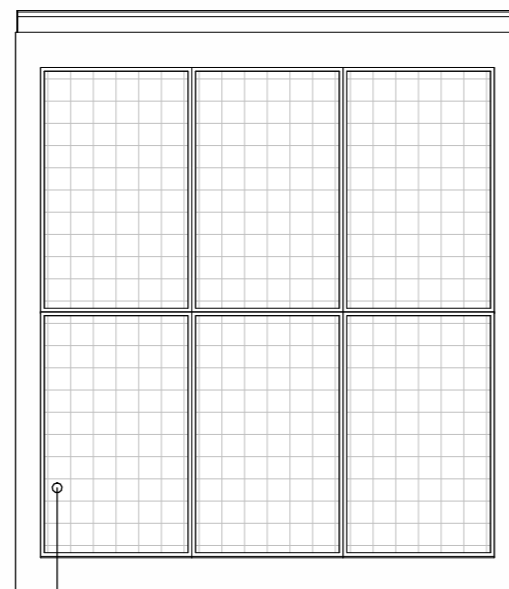

Dakaanzicht

maximaal aantal pv-panelen weergegeven
aantal kan verschillen per woning/berging



3D aanzicht

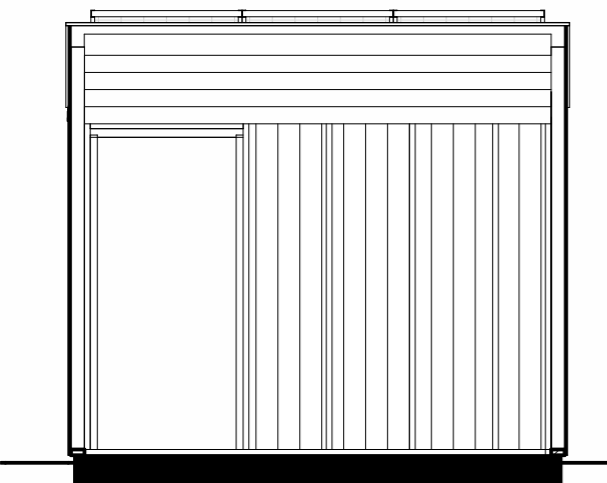

Doorsnede A-A

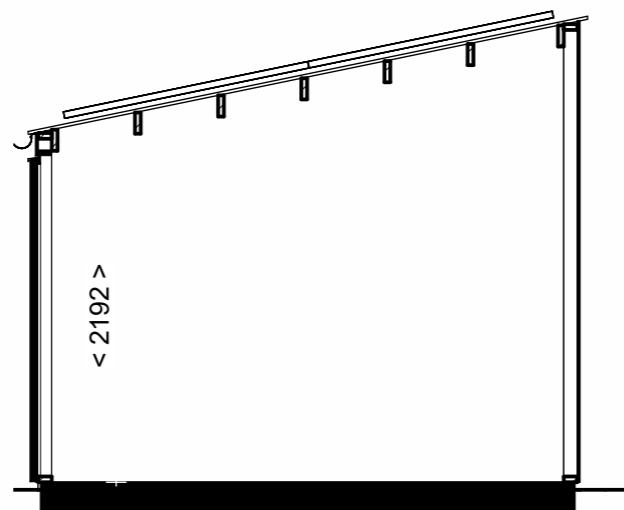

Doorsnede B-B

ALLEMAAL
YIELEYAAL

Getekend: bnr. -
Gespiegeld: bnr. 395

Tekening: Berging C

Woningtype: -

Bouwnummer: 395

Bladnummer: VT-BE08

Schaal: 1:50

Datum: 02-12-2024



Voorgevel

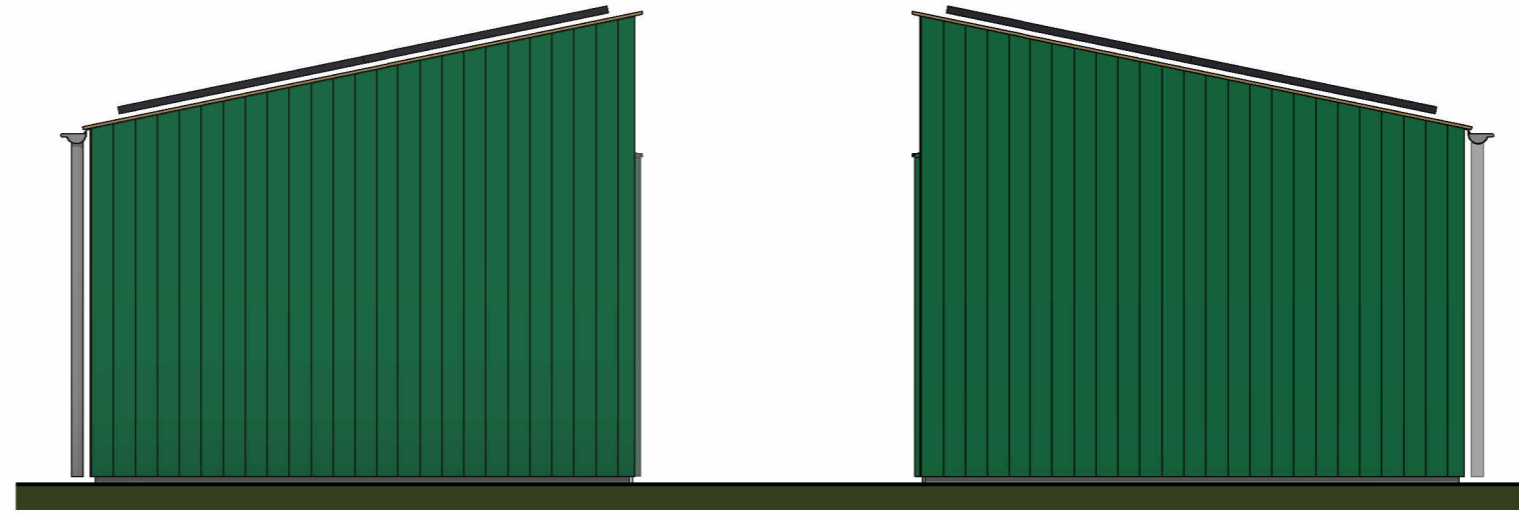

Linker zijgevel

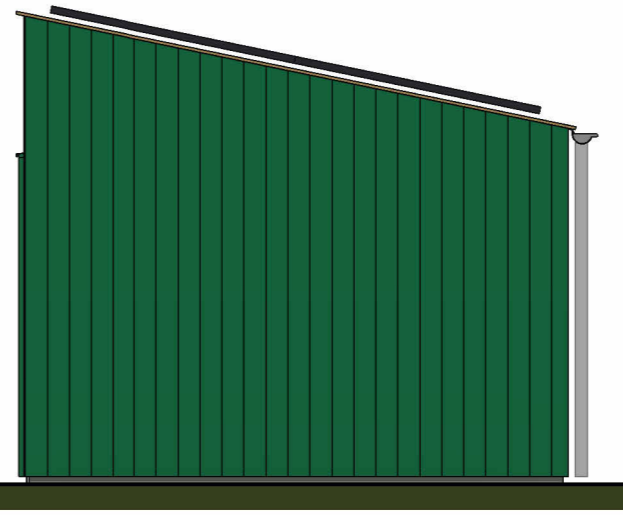

Rechter zijgevel



Achtergevel

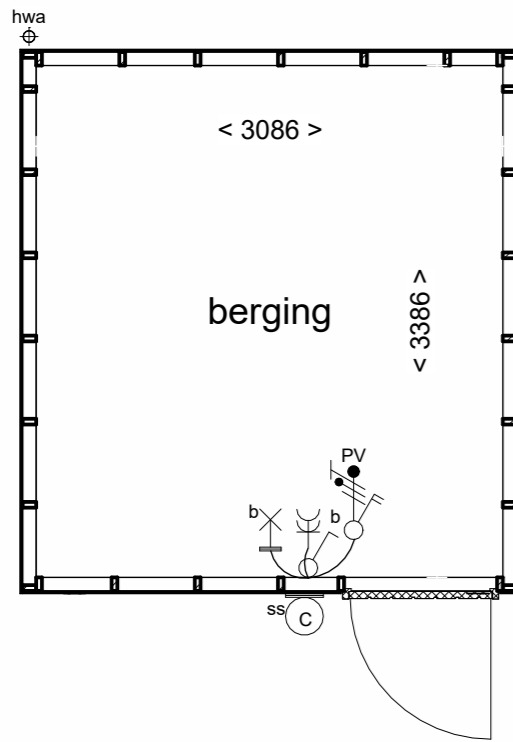

Begane grond

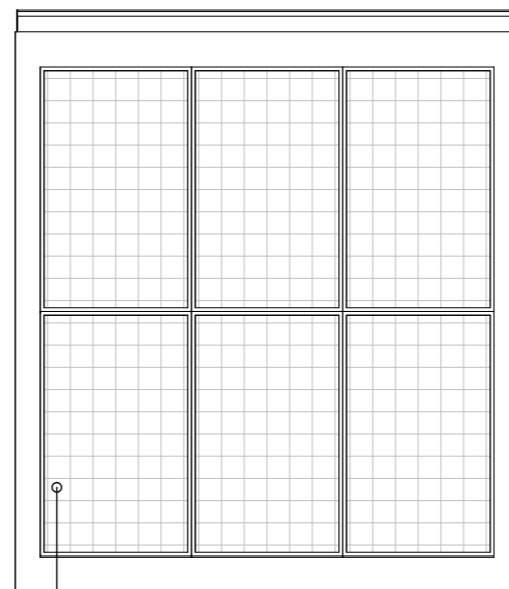

Dakaanzicht

maximaal aantal pv-panelen weergegeven
aantal kan verschillen per woning/berging

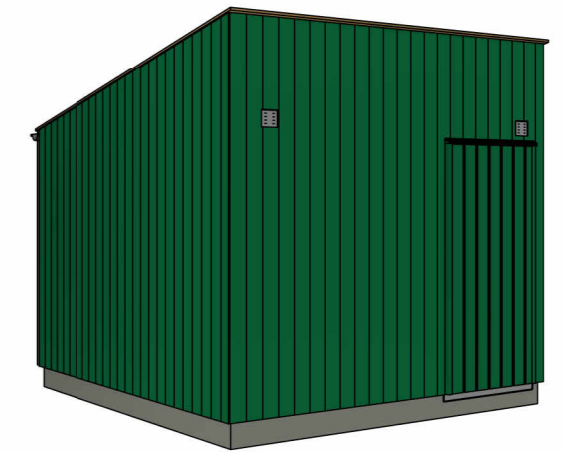

3D aanzicht

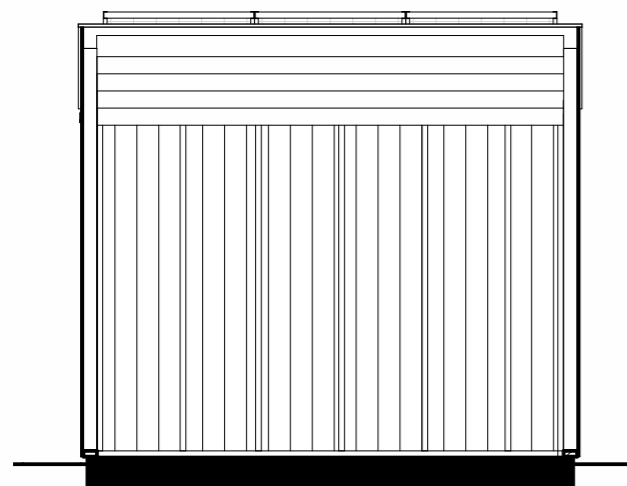

Doorsnede A-A

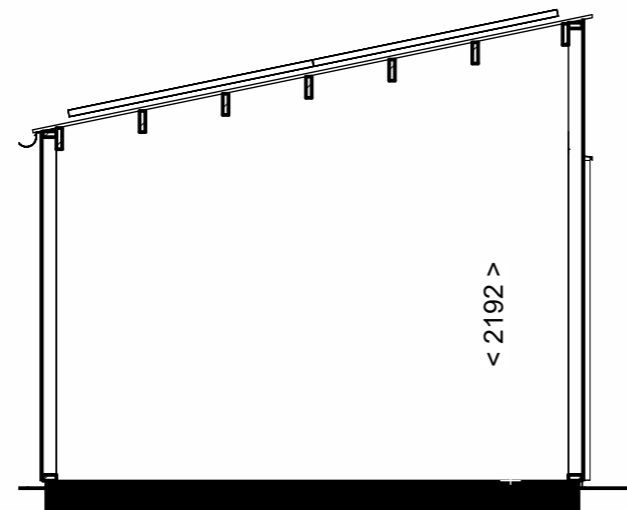

Doorsnede B-B

ALLEMAAL
YIELEYAAL

Getekend:
bnr. 427
bnr. 436

Tekening: Berging C1

Woningtype: -

Bouwnummer: 427, 436

Bladnummer: VT-BE09

Schaal: 1:50

Datum: 02-12-2024